

## 规格/TECHNICAL SPECIFICATIONS

型号/MODEL NUMBER:	I LENS502-S15-3045-NH
透镜尺寸/LENS DIMENSIONS:	14.9*14.9*8.2MM
定位方式/FASTENING:	打胶/Glue
是否符合ROHS/ROHS COMPLIANT:	是/YES

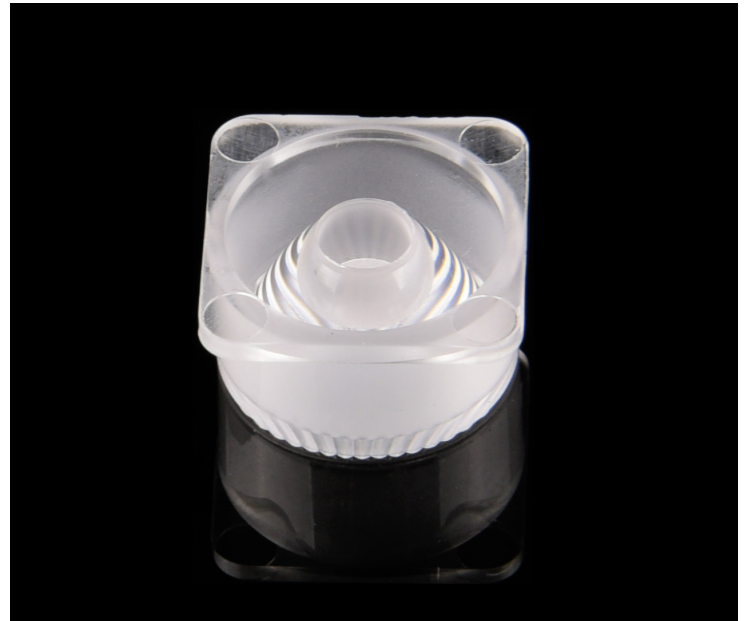

### 说明/CHARACTERISTIC:

1. 透镜有多种不同的配光角度。  
The lens have multiple types beam angles .
2. 一体化镜头无支架。  
The integrated lens has no holder.
3. 兼容多种灯珠。  
Compatible with various lamp beads.
4. 适用于道路护栏灯杆, 桥梁灯, 室内橱柜灯。  
Application: road guardrail lighting, bridge lighting, cabinet lighting.
5. 与市面上同类镜头相比, 光效更好, 光斑更漂亮, 兼容性更好。  
Compared with similar type lenses on the market, with better light effect , more beautiful spot and better compatibility.

LED:LUMINUS 3030  
 角度/FWHM:26\*54°  
 光效/Efficiency:71%  
 峰值强度/Peakintensity:1.8CD/LM  
 光学面数量/LED/each optic:1  
 灯光颜色/Light colour:白色/White  
 所需组件/Required components:

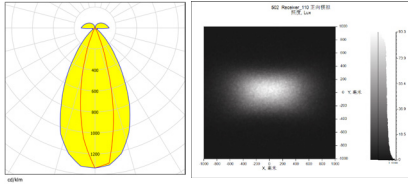

LED:SAMSUNG 3030  
 角度/FWHM:26\*55°  
 光效/Efficiency:71%  
 峰值强度/Peakintensity:1.8CD/LM  
 光学面数量/LED/each optic:1  
 灯光颜色/Light colour:白色/White  
 所需组件/Required components:

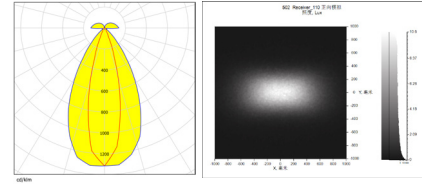

LED:LUMINUS 2835  
 角度/FWHM:29\*54°  
 光效/Efficiency:71%  
 峰值强度/Peakintensity:1.6CD/LM  
 光学面数量/LED/each optic:1  
 灯光颜色/Light colour:白色/White  
 所需组件/Required components:

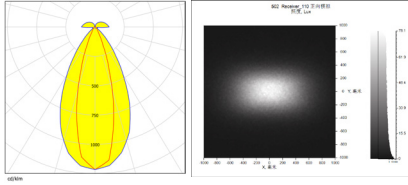

LED:SAMSUNG 2835  
 角度/FWHM:27\*55°  
 光效/Efficiency:71%  
 峰值强度/Peakintensity:1.8CD/LM  
 光学面数量/LED/each optic:1  
 灯光颜色/Light colour:白色/White  
 所需组件/Required components:

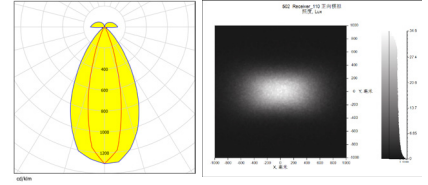

LED:CREE 3030  
 角度/FWHM:27\*55°  
 光效/Efficiency:71%  
 峰值强度/Peakintensity:1.7CD/LM  
 光学面数量/LED/each optic:1  
 灯光颜色/Light colour:白色/White  
 所需组件/Required components:

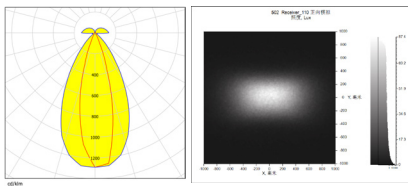

LED:LEXTAR 3030  
 角度/FWHM:28\*55°  
 光效/Efficiency:71%  
 峰值强度/Peakintensity:1.7CD/LM  
 光学面数量/LED/each optic:1  
 灯光颜色/Light colour:白色/White  
 所需组件/Required components:

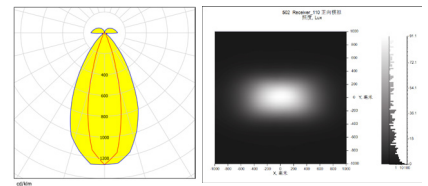

LED:CREE 2835  
 角度/FWHM:27\*55°  
 光效/Efficiency:71%  
 峰值强度/Peakintensity:1.7CD/LM  
 光学面数量/LED/each optic:1  
 灯光颜色/Light colour:白色/White  
 所需组件/Required components:

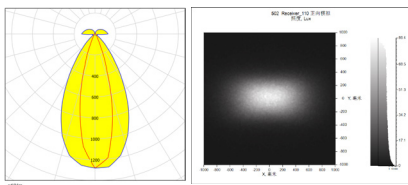

LED:LEXTAR 2835  
 角度/FWHM:27\*54°  
 光效/Efficiency:71%  
 峰值强度/Peakintensity:1.8CD/LM  
 光学面数量/LED/each optic:1  
 灯光颜色/Light colour:白色/White  
 所需组件/Required components:

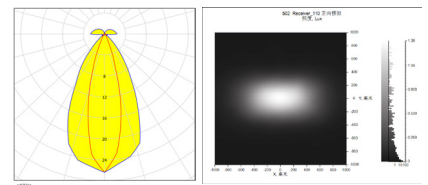

CAD

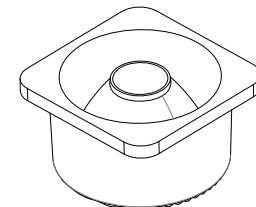
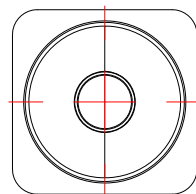
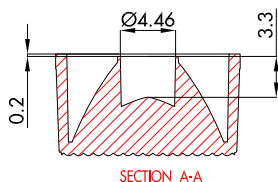
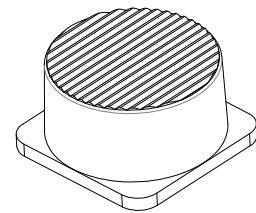
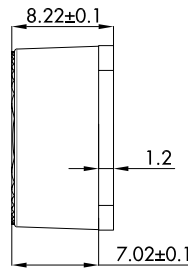
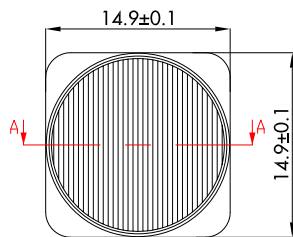

注意/NOTE:

1. 镜片表面应光滑无划痕、气泡、凹痕和黑点。

The surface of the lens should be smooth without scratches, bubbles, dents and black spots.

GENERAL TOLERANCES ISO2768-M (UNLESS STATED) 一般公差ISO 2768-M (除非另有说明)	MATERIAL 材质	PC	DRAWING TITLE 绘图标题	ILENS502-S15-3045-NH
LINEAR/线性	0~5±0.05		5~10±0.1	10~30±0.15
ANGULAR/角度	0°~10°±1°		10°~50°±0.5°	50°~120°±0.3°

# 产品包装/Products Packaging

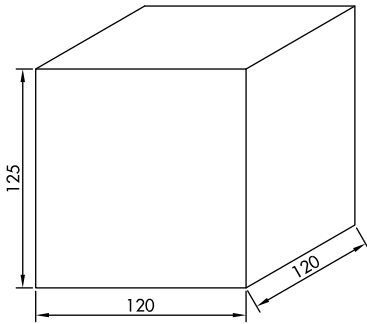

内盒  
cardboard box(S)

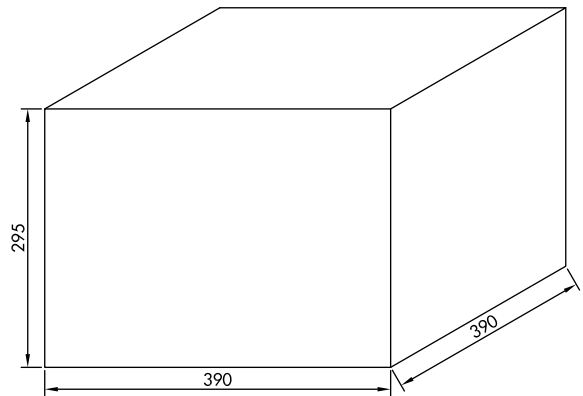

外盒  
cardboard box(M) 2:1

型号/Part No.	数量/QTY
ILENS502-S15-3045-NH	12600pcs
PE袋/PE bag	700pcs
内盒/cardboard box (S)	18pcs
外盒/cardboard box (M)	1pcs

示意图/The schematic diagram :



700PCS

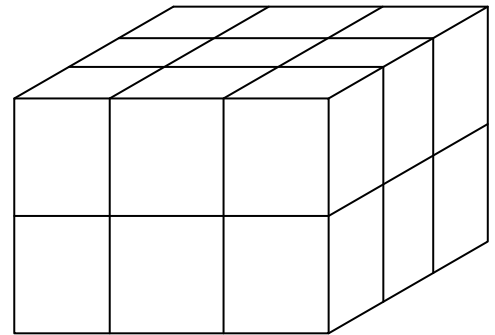
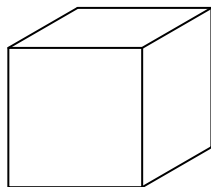

700pcs\*18=12600pcs