

规格/TECHNICAL SPECIFICATIONS

| | |
|--------------------------|-----------------------|
| 型号/MODEL NUMBER: | I LENS915-S10-M60-H |
| 透镜尺寸/LENS DIMENSIONS: | Φ8.85*5.45MM |
| 支架尺寸/HOLDER DIMENSIONS: | Φ10.02*6.5MM |
| 定位方式/FASTENING: | 打胶/贴胶/定位柱/Type or Pin |
| 是否符合ROHS/ROHS COMPLIANT: | 是/YES |



| Holder Part No./支架零件号 | Colour /颜色 | Specification/规格 | Function/功能 | Fastening/固定 |
|-----------------------|------------|------------------|-------------------------------------------------|---------------|
| H915H1-3030 | Black/黑色 | | Adapting 3030 LED 适配 3030 LED | Type 打胶/贴胶 |
| H915H2-3030 | White/白色 | | | |
| H915H1-3535 | Black/黑色 | | Adapting 3535 LED 适配 3535 LED | PIN 定位柱 |
| H915H2-3535 | White/白色 | | | |
| H915H1-P | Black/黑色 | | Adapting 3030 or 3535 LED 适配 3030 或 3535 LED | PIN 定位柱 |
| H915H2-P | White/白色 | | | |

说明/CHARACTERISTIC:

- 透镜有多种不同的配光角度。
The lens have multiple types beam angles.
- 六种不同的支架来匹配不同LED, 贴胶或者定位柱定位安装。
With 6 type brackets to match different leds, Self-adhesive tape or pins for fix.
- 兼容多种灯珠。
Compatible with various lamp beads.
- 适用于洗墙灯和投光灯。
Suitable for wall washing lighting and floodlights.
- 与市面上同类镜头相比, 光效更好, 光斑更漂亮, 兼容性更好。
Compared with similar type lenses on the market, with better light effect, more beautiful spot and better compatibility.

LED:CREE XPE2
 角度/FWHM:63°
 光效/Efficiency:90%
 峰值强度/Peakintensity:1CD/LM
 光学面数量/LED/each optic:1
 灯光颜色/Light colour:白色/White
 所需组件/Required components:

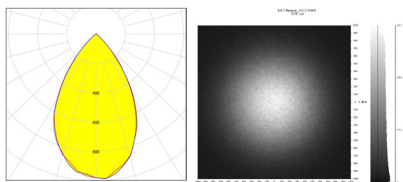

LED:LUMILEDS HL2X
 角度/FWHM:61°
 光效/Efficiency:90%
 峰值强度/Peakintensity:0.95CD/LM
 光学面数量/LED/each optic:1
 灯光颜色/Light colour:白色/White
 所需组件/Required components:

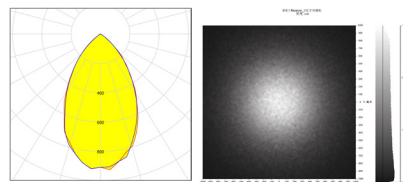

LED:CREE XPG2
 角度/FWHM:61°
 光效/Efficiency:90%
 峰值强度/Peakintensity:1CD/LM
 光学面数量/LED/each optic:1
 灯光颜色/Light colour:白色/White
 所需组件/Required components:

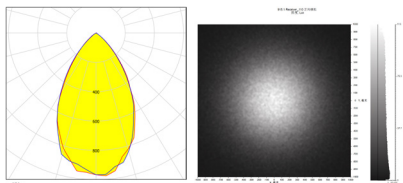

LED:LUMILEDS 3030
 角度/FWHM:56°
 光效/Efficiency:90%
 峰值强度/Peakintensity:1.2CD/LM
 光学面数量/LED/each optic:1
 灯光颜色/Light colour:白色/White
 所需组件/Required components:

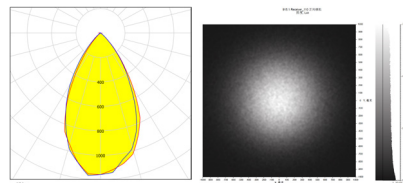

LED:CREE XBD
 角度/FWHM:57°
 光效/Efficiency:90%
 峰值强度/Peakintensity:1.1CD/LM
 光学面数量/LED/each optic:1
 灯光颜色/Light colour:白色/White
 所需组件/Required components:

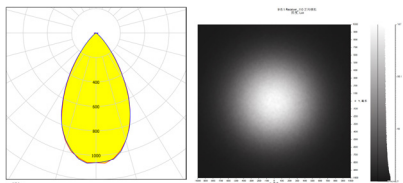

LED:OSRAM P3030
 角度/FWHM:57°
 光效/Efficiency:90%
 峰值强度/Peakintensity:1.2CD/LM
 光学面数量/LED/each optic:1
 灯光颜色/Light colour:白色/White
 所需组件/Required components:

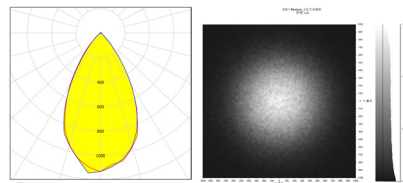

LED:LG 3535
 角度/FWHM:61°
 光效/Efficiency:90%
 峰值强度/Peakintensity:0.9CD/LM
 光学面数量/LED/each optic:1
 灯光颜色/Light colour:白色/White
 所需组件/Required components:

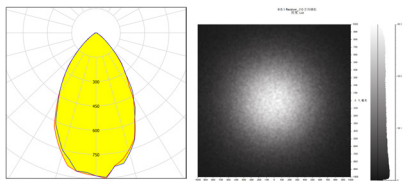

LED:SEOUL SZ5
 角度/FWHM:53°
 光效/Efficiency:90%
 峰值强度/Peakintensity:1.2CD/LM
 光学面数量/LED/each optic:1
 灯光颜色/Light colour:白色/White
 所需组件/Required components:

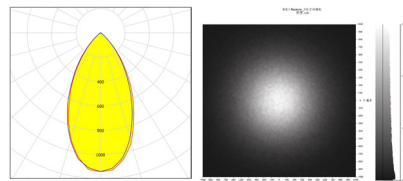

CAD

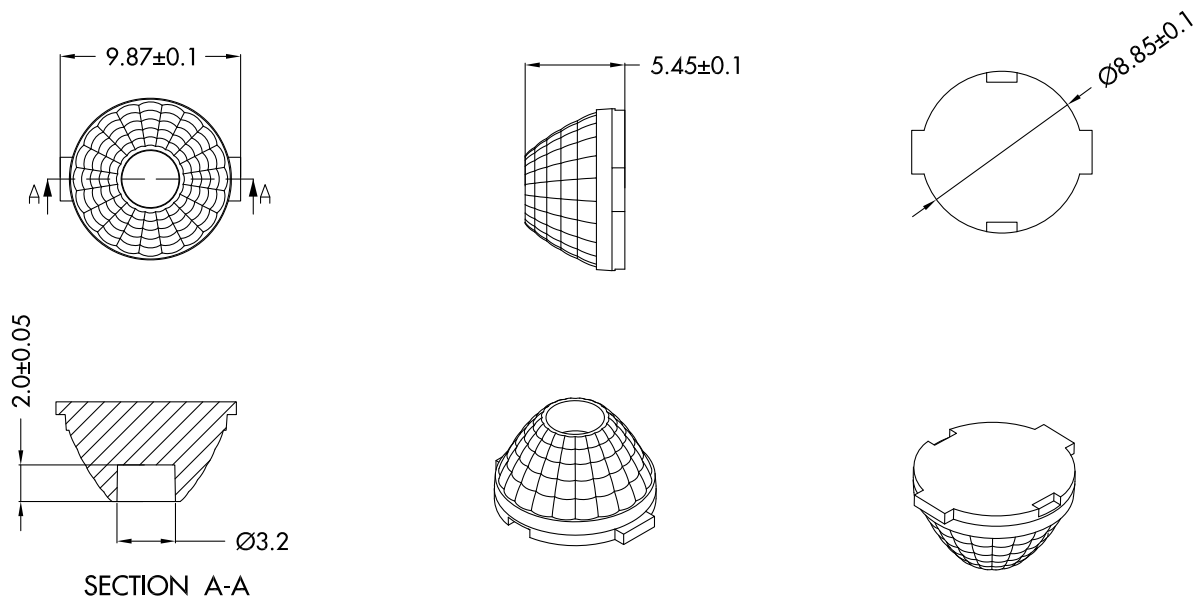

注意/NOTE:

1. 镜片表面应光滑无划痕、气泡、凹痕和黑点。

The surface of the lens should be smooth without scratches, bubbles, dents and black spots.

| GENERAL TOLERANCES ISO2768-M (UNLESS STATED) 一般公差ISO 2768-M (除非另有说明) | MATERIAL 材质 | PMMA | DRAWING TITLE 绘图标题 | I LENS915-S10-M60-H |
|----------------------------------------------------------------------------|----------------|------|-----------------------|---------------------|
| LINEAR/线性 | 0~5±0.05 | | 5~10±0.1 | 10~30±0.15 |
| ANGULAR/角度 | 0°~10°±1° | | 10°~50°±0.5° | 50°~120°±0.3° |

H915H1-3030/H915H2-3030

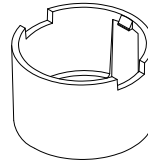
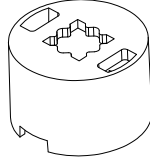
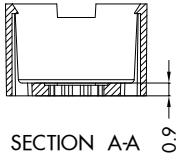
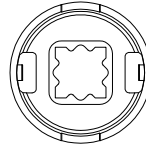
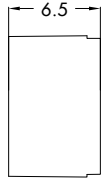
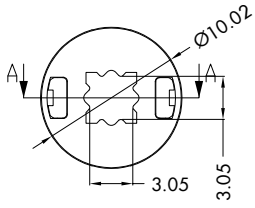

| 材质/MATERIL | PC |
|---------------|----|
| 线性/LINEAR | |
| 0~5±0.05 | |
| 5~10±0.1 | |
| 10~30±0.15 | |
| 角度/ANGULAR | |
| 0°~10°±1° | |
| 10°~50°±0.5° | |
| 50°~120°±0.3° | |

H915H1-3535/H915H2-3535

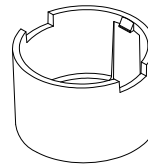
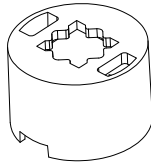
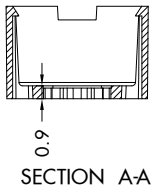
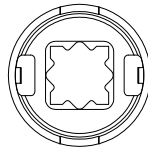
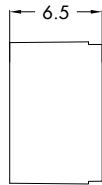
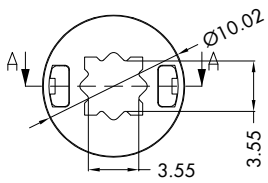

| 材质/MATERIL | PC |
|---------------|----|
| 线性/LINEAR | |
| 0~5±0.05 | |
| 5~10±0.1 | |
| 10~30±0.15 | |
| 角度/ANGULAR | |
| 0°~10°±1° | |
| 10°~50°±0.5° | |
| 50°~120°±0.3° | |

H915H1-P/H915H2-P

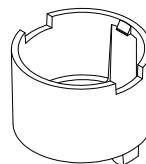
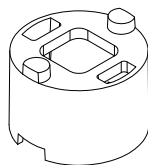
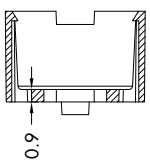
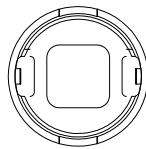
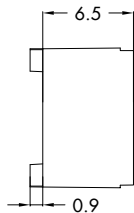
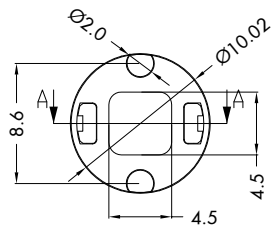

| 材质/MATERIL | PC |
|---------------|----|
| 线性/LINEAR | |
| 0~5±0.05 | |
| 5~10±0.1 | |
| 10~30±0.15 | |
| 角度/ANGULAR | |
| 0°~10°±1° | |
| 10°~50°±0.5° | |
| 50°~120°±0.3° | |

产品包装/Products Packaging

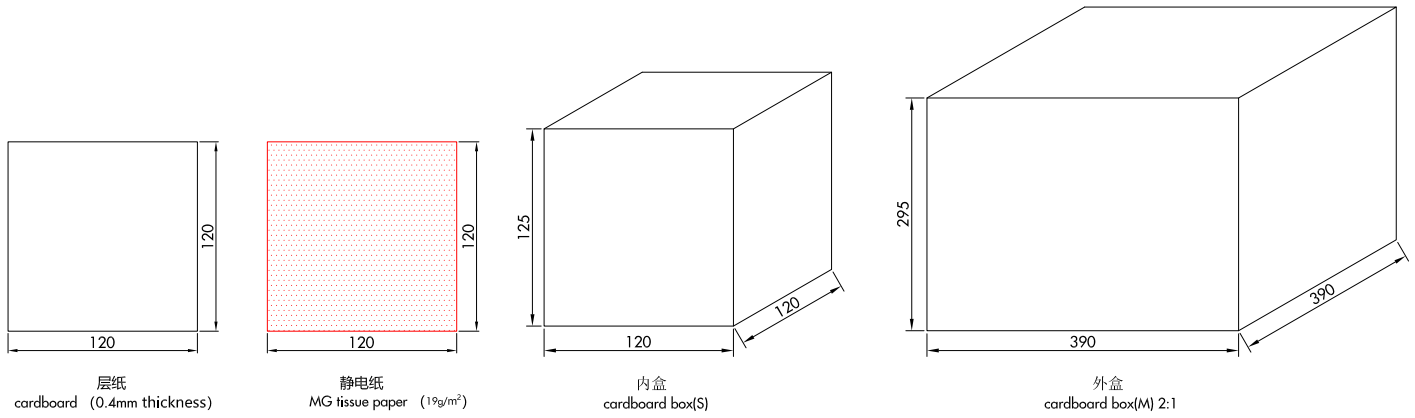

示意图/The schematic diagram:

| 型号/Part No. | 数量/QTY |
|-------------------------------------------|----------|
| I LENS915-S10-M60-H915H1-P/H915H2-P | 41472pcs |
| 静电纸/MG tissue paper (19g/m ²) | 288pcs |
| 层纸/cardboard (0.4mm thickness) | 306pcs |
| 内盒/cardboard box (S) | 18pcs |
| 外盒/cardboard box (M) | 1pcs |

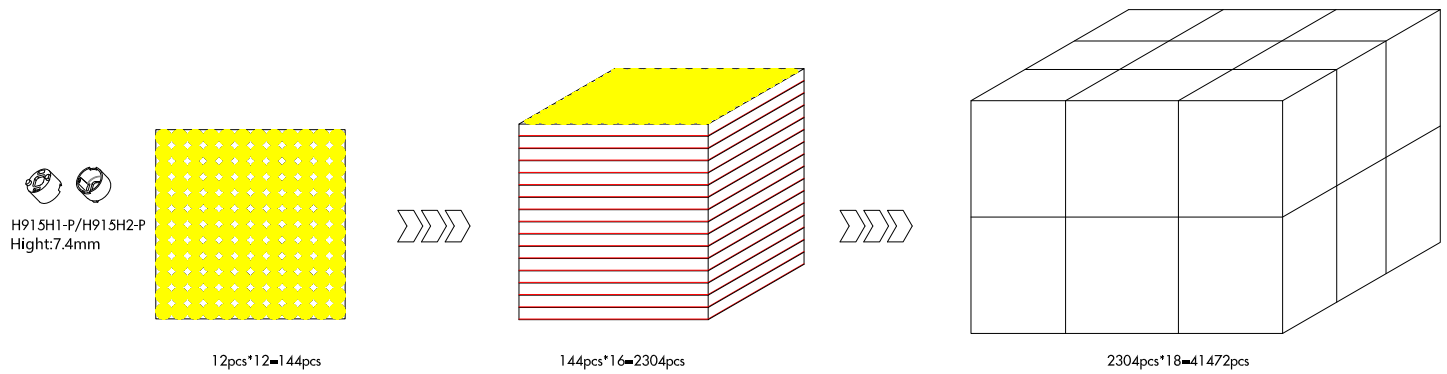

示意图/The schematic diagram:

| 型号/Part No. | 数量/QTY |
|----------------------------------------------------------|----------|
| I LENS915-S10-M60-H915H1-3535 (3030) /H915H2-3535 (3030) | 14976pcs |
| 静电纸/MG tissue paper (19g/m ²) | 324pcs |
| 层纸/cardboard (0.4mm thickness) | 342pcs |
| 内盒/cardboard box (S) | 18pcs |
| 外盒/cardboard box (M) | 1pcs |

示意图/The schematic diagram:

