

规格/TECHNICAL SPECIFICATIONS

型号/MODEL NUMBER:	I LENS915-S10-B35-H
透镜尺寸/LENS DIMENSIONS:	Φ8.90*5.60MM
支架尺寸/HOLDER DIMENSIONS:	Φ10.02*6.5MM
定位方式/FASTENING:	打胶/贴胶/定位柱/Type or Pin
是否符合ROHS/ROHS COMPLIANT:	是/YES

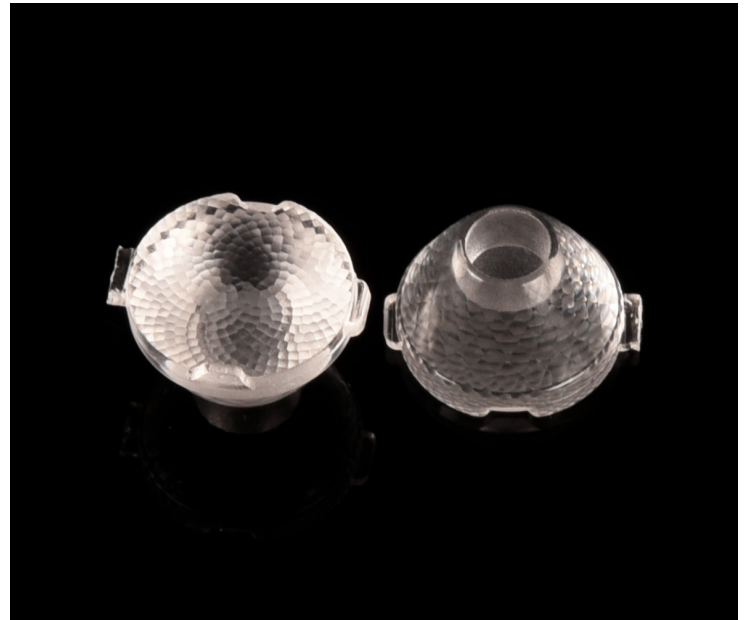
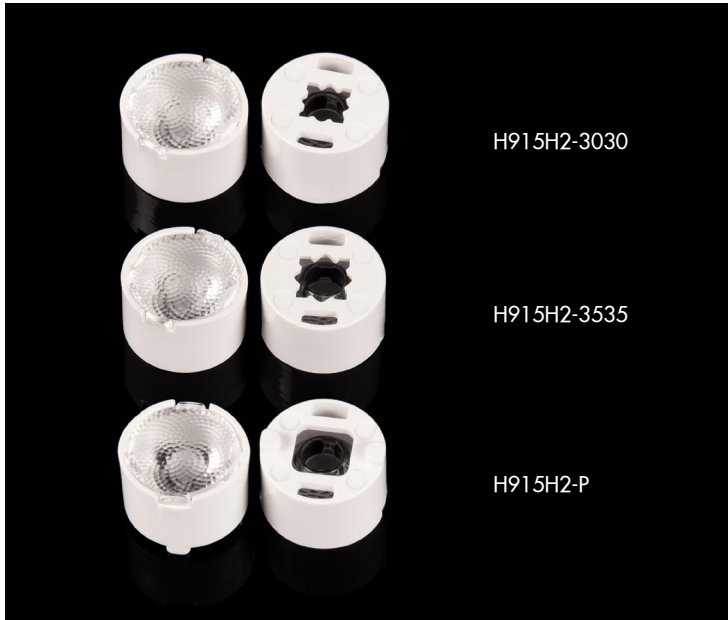

Holder Part No./支架零件号	Colour /颜色	Specification/规格	Function/功能	Fastening/固定
H915H1-3030	Black/黑色		Adapting 3030 LED 适配 3030 LED	Type 打胶/贴胶
H915H2-3030	White/白色			
H915H1-3535	Black/黑色		Adapting 3535 LED 适配 3535 LED	PIN 定位柱
H915H2-3535	White/白色			
H915H1-P	Black/黑色		Adapting 3030 or 3535 LED 适配 3030 或 3535 LED	PIN 定位柱
H915H2-P	White/白色			

说明/CHARACTERISTIC:

- 透镜有多种不同的配光角度。
The lens have multiple types beam angles.
- 六种不同的支架来匹配不同LED, 贴胶或者定位柱定位安装。
With 6 type brackets to match different leds, Self-adhesive tape or pins for fix.
- 兼容多种灯珠。
Compatible with various lamp beads.
- 适用于洗墙灯和投光灯。
Suitable for wall washing lighting and floodlights.
- 与市面上同类镜头相比, 光效更好, 光斑更漂亮, 兼容性更好。
Compared with similar type lenses on the market,with better light effect ,more beautiful spot and better compatibility.

LED:CREE XPE2
 角度/FWHM:37°
 光效/Efficiency:90%
 峰值强度/Peakintensity:2.1CD/LM
 光学面数量/LED/each optic:1
 灯光颜色/Light colour:白色/White
 所需组件/Required components:

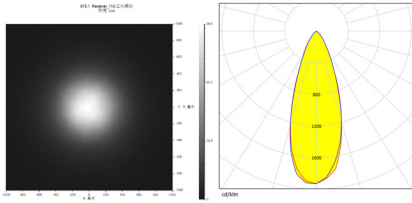

LED:LUMILEDS HL2X
 角度/FWHM:37°
 光效/Efficiency:90%
 峰值强度/Peakintensity:1.8CD/LM
 光学面数量/LED/each optic:1
 灯光颜色/Light colour:白色/White
 所需组件/Required components:

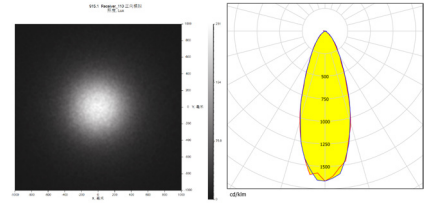

LED:CREE XPG2
 角度/FWHM:38°
 光效/Efficiency:90%
 峰值强度/Peakintensity:1.9CD/LM
 光学面数量/LED/each optic:1
 灯光颜色/Light colour:白色/White
 所需组件/Required components:

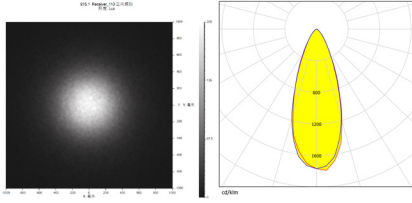

LED:LUMILEDS 3030
 角度/FWHM:30°
 光效/Efficiency:90%
 峰值强度/Peakintensity:2.9CD/LM
 光学面数量/LED/each optic:1
 灯光颜色/Light colour:白色/White
 所需组件/Required components:

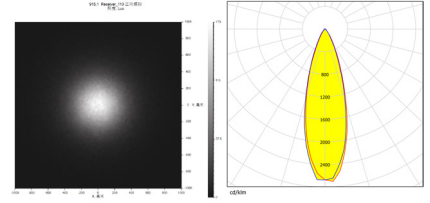

LED:CREE XBD
 角度/FWHM:32°
 光效/Efficiency:90%
 峰值强度/Peakintensity:2.5CD/LM
 光学面数量/LED/each optic:1
 灯光颜色/Light colour:白色/White
 所需组件/Required components:

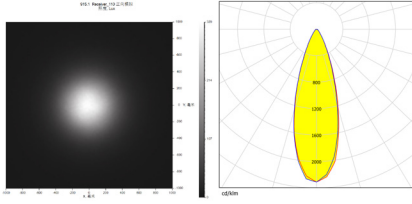

LED:OSRAM P3030
 角度/FWHM:28°
 光效/Efficiency:90%
 峰值强度/Peakintensity:3.1CD/LM
 光学面数量/LED/each optic:1
 灯光颜色/Light colour:白色/White
 所需组件/Required components:

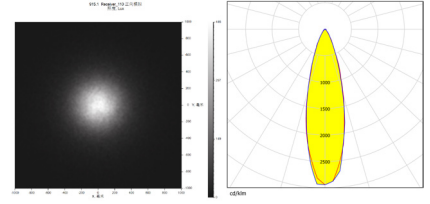

LED:LG 3535
 角度/FWHM:37°
 光效/Efficiency:90%
 峰值强度/Peakintensity:1.8CD/LM
 光学面数量/LED/each optic:1
 灯光颜色/Light colour:白色/White
 所需组件/Required components:

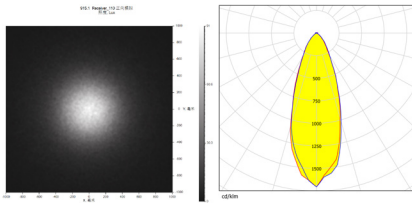

LED:SEOUL SZ5
 角度/FWHM:35°
 光效/Efficiency:90%
 峰值强度/Peakintensity:2.1CD/LM
 光学面数量/LED/each optic:1
 灯光颜色/Light colour:白色/White
 所需组件/Required components:

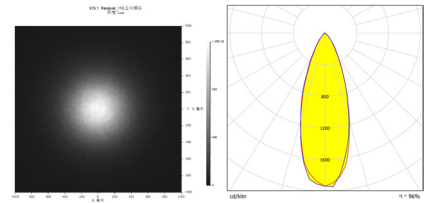

CAD

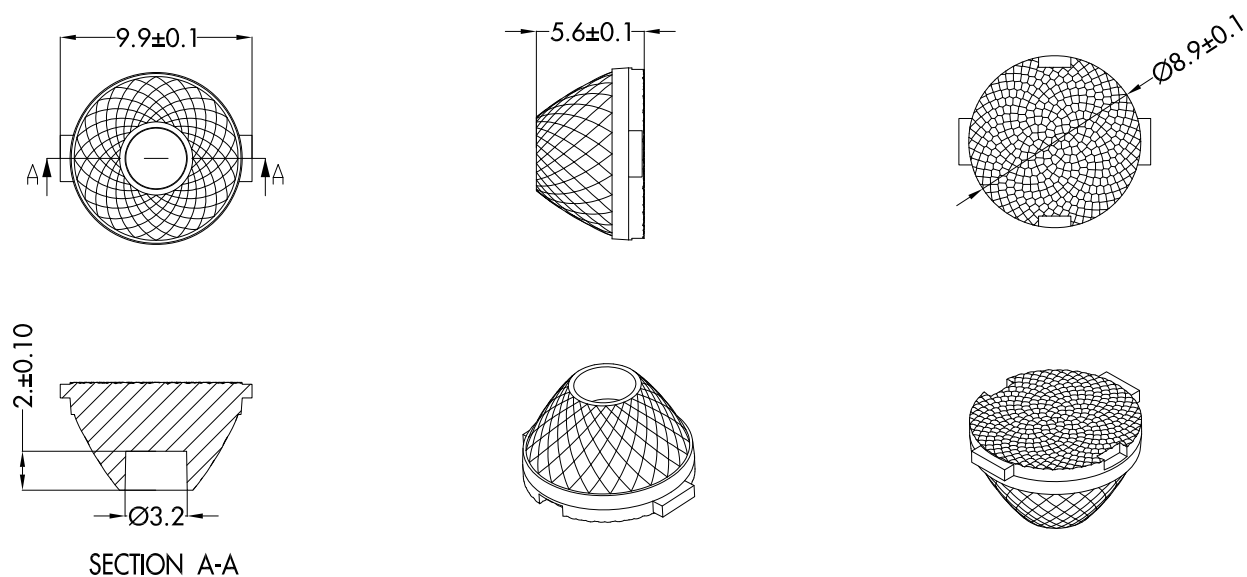

注意/NOTE:

1. 镜片表面应光滑无划痕、气泡、凹痕和黑点。

The surface of the lens should be smooth without scratches, bubbles, dents and black spots.

GENERAL TOL ERANCES ISO2768-M (UNLESS STATED) 一般公差ISO 2768-M(除非另有说明)	MATERIL 材质	PMMA	DRAWING TITLE 绘图标题	I LENS915-S10-B35-H
LINEAR/线性	0~5±0.05		5~10±0.1	10~30±0.15
ANGULAR/角度	0°~10°±1°		10°~50°±0.5°	50°~120°±0.3°

H915H1-3030/H915H2-3030

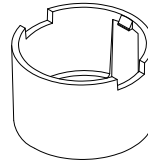
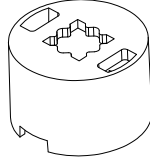
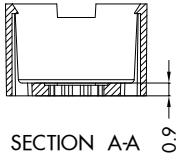
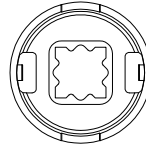
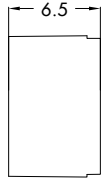
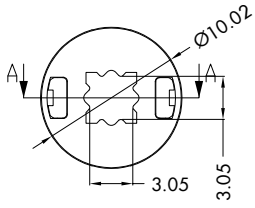

材质/MATERIL	PC
线性/LINEAR	
0~5±0.05	
5~10±0.1	
10~30±0.15	
角度/ANGULAR	
0°~10°±1°	
10°~50°±0.5°	
50°~120°±0.3°	

H915H1-3535/H915H2-3535

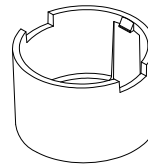
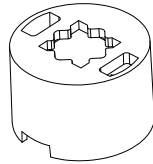
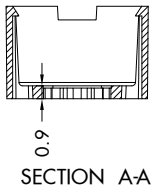
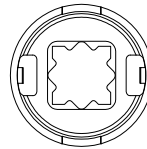
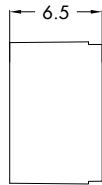
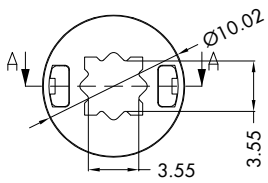

材质/MATERIL	PC
线性/LINEAR	
0~5±0.05	
5~10±0.1	
10~30±0.15	
角度/ANGULAR	
0°~10°±1°	
10°~50°±0.5°	
50°~120°±0.3°	

H915H1-P/H915H2-P

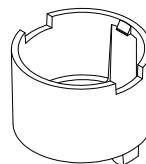
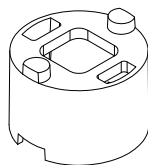
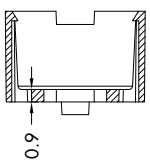
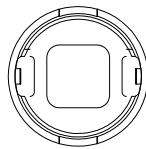
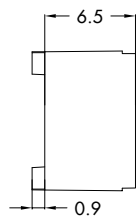
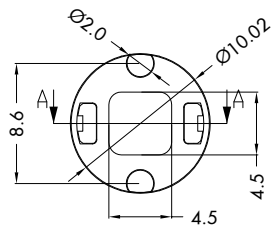

材质/MATERIL	PC
线性/LINEAR	
0~5±0.05	
5~10±0.1	
10~30±0.15	
角度/ANGULAR	
0°~10°±1°	
10°~50°±0.5°	
50°~120°±0.3°	

产品包装/Products Packaging

型号/Part No.	数量/QTY
I LENS915-S10-B35-H915H1-3535 (3030)/H915H2-3535 (3030)	36000pcs
内盒/cardboard box(S)	18pcs
外盒/cardboard box(M)	1pcs



2000pcs

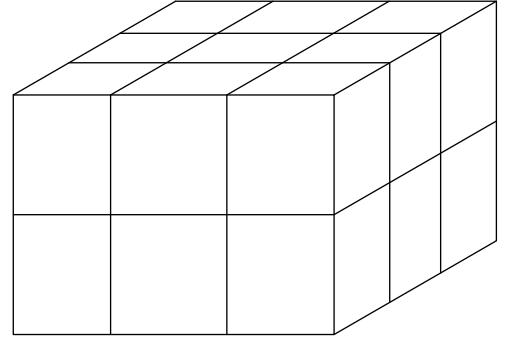
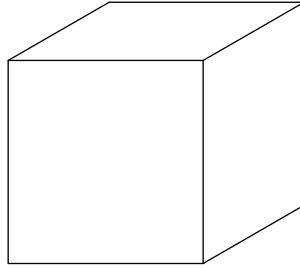

2000pcs*18=36000pcs