

规格/TECHNICAL SPECIFICATIONS

型号/MODEL NUMBER:	I LENS648-R7575-B45-25H1-NH
透镜尺寸/LENS DIMENSIONS:	74.80*74.80*9.40MM
定位方式/FASTENING:	定位柱/Pin
是否符合ROHS/ROHS COMPLIANT:	是/YES

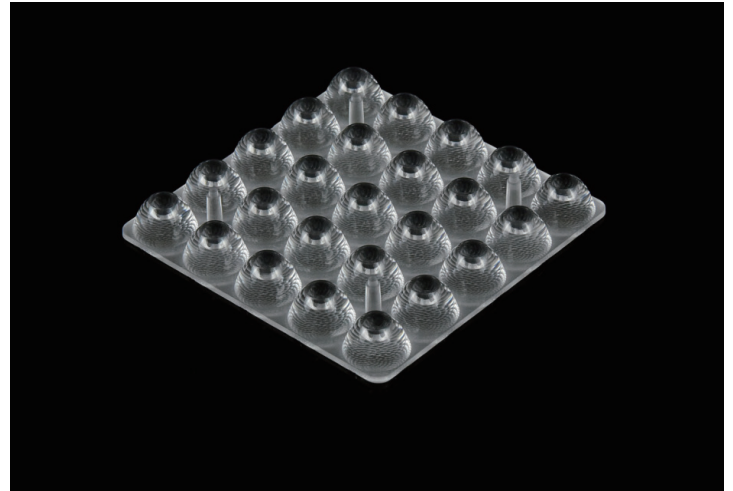
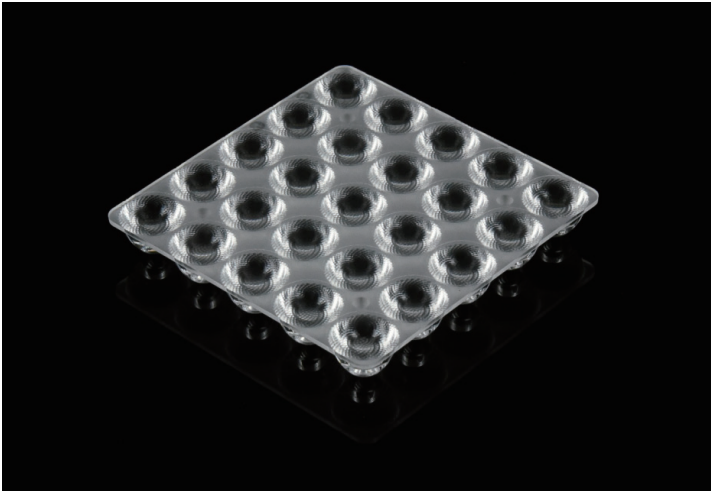

说明/CHARACTERISTIC:

1. 透镜有多种不同的配光角度。
The lens have multiple types beam angles .
2. 一体化透镜不需要支架和硅胶圈。
Integrated lens eliminates the need for holders and silicone gaskets.
3. 兼容多种灯珠。
Compatible with various lamp beads.
4. 适用于洗墙灯、投光灯。
Suitable for wall washer, flood light.
5. 与市面上同类镜头相比, 光效更好, 光斑更漂亮, 兼容性更好。
Compared with similar lenses on the market, the light effect is better, the spot is more beautiful, and the compatibility is better.

LED:CREE XPE2
 角度/FWHM:50°
 光效/Efficiency:94%
 峰值强度/Peakintensity:1.5CD/LM
 光学面数量/LED/each optic:25
 灯光颜色/Light colour:白色/White
 所需组件/Required components:

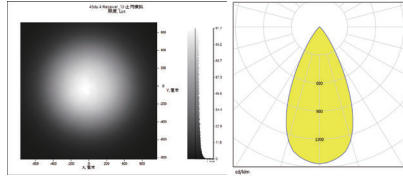

LED:CREE XPG2
 角度/FWHM:52°
 光效/Efficiency:94%
 峰值强度/Peakintensity:1.4CD/LM
 光学面数量/LED/each optic:25
 灯光颜色/Light colour:白色/White
 所需组件/Required components:

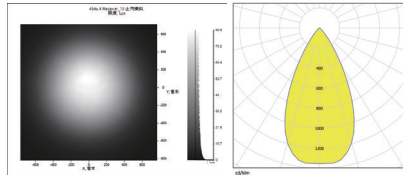

LED:CREE XPG3
 角度/FWHM:53.3°
 光效/Efficiency:94%
 峰值强度/Peakintensity:1.3CD/LM
 光学面数量/LED/each optic:25
 灯光颜色/Light colour:白色/White
 所需组件/Required components:

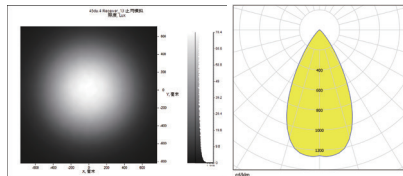

LED:CREE XML2
 角度/FWHM:52°
 光效/Efficiency:94%
 峰值强度/Peakintensity:1.3CD/LM
 光学面数量/LED/each optic:25
 灯光颜色/Light colour:白色/White
 所需组件/Required components:

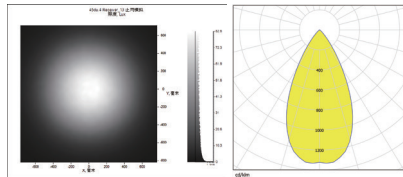

LED:CREE XML3
 角度/FWHM:61°
 光效/Efficiency:94%
 峰值强度/Peakintensity:1.0CD/LM
 光学面数量/LED/each optic:25
 灯光颜色/Light colour:白色/White
 所需组件/Required components:

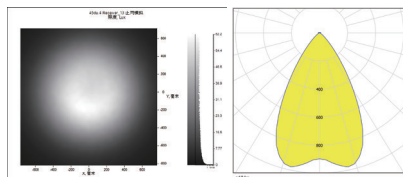

LED:CREE XPL2
 角度/FWHM:54.4°
 光效/Efficiency:94%
 峰值强度/Peakintensity:1.2CD/LM
 光学面数量/LED/each optic:25
 灯光颜色/Light colour:白色/White
 所需组件/Required components:

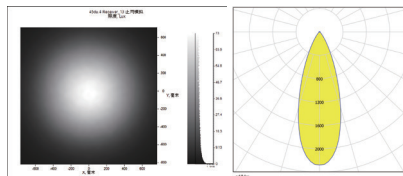

LED:CREE XD16
 角度/FWHM:34°
 光效/Efficiency:94%
 峰值强度/Peakintensity:2.4CD/LM
 光学面数量/LED/each optic:25
 灯光颜色/Light colour:白色/White
 所需组件/Required components:

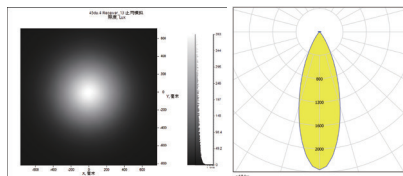

LED:LUXEON 3030 2D
 角度/FWHM:33°
 光效/Efficiency:94%
 峰值强度/Peakintensity:2.6CD/LM
 光学面数量/LED/each optic:25
 灯光颜色/Light colour:白色/White
 所需组件/Required components:

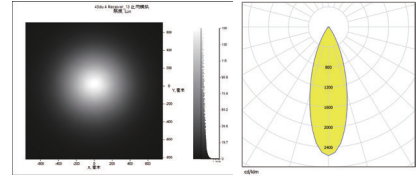

LED:LUXEON TX
 角度/FWHM:38.8°
 光效/Efficiency:94%
 峰值强度/Peakintensity:2.1CD/LM
 光学面数量/LED/each optic:25
 灯光颜色/Light colour:白色/White
 所需组件/Required components:

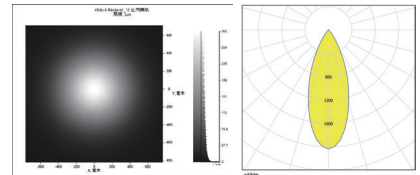

LED:LUXEON LUXEON Rebel
 角度/FWHM:40°
 光效/Efficiency:94%
 峰值强度/Peakintensity:2.0CD/LM
 光学面数量/LED/each optic:25
 灯光颜色/Light colour:白色/White
 所需组件/Required components:

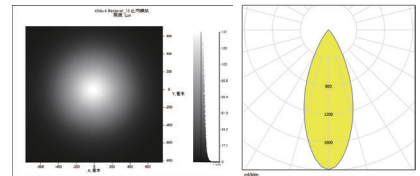

LED:SAMSUNG LH351B
 角度/FWHM:53°
 光效/Efficiency:94%
 峰值强度/Peakintensity:1.3CD/LM
 光学面数量/LED/each optic:25
 灯光颜色/Light colour:白色/White
 所需组件/Required components:

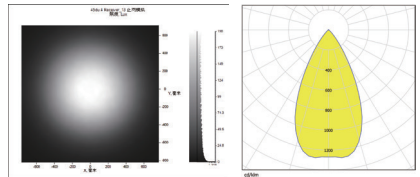

LED:SAMSUNG LM281B
 角度/FWHM:34°
 光效/Efficiency:94%
 峰值强度/Peakintensity:2.5CD/LM
 光学面数量/LED/each optic:25
 灯光颜色/Light colour:白色/White
 所需组件/Required components:

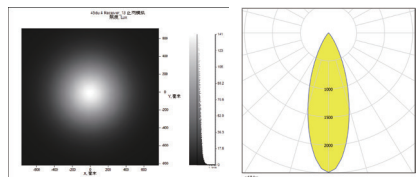

LED:OSRAM 3737
 角度/FWHM:37.7°
 光效/Efficiency:94%
 峰值强度/Peakintensity:2.2CD/LM
 光学面数量/LED/each optic:25
 灯光颜色/Light colour:白色/White
 所需组件/Required components:

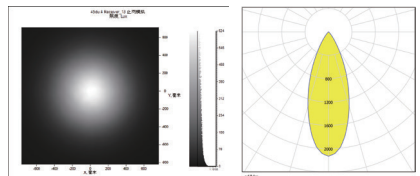

LED:LUXEON 5050
 角度/FWHM:45°
 光效/Efficiency:94%
 峰值强度/Peakintensity:1.7CD/LM
 光学面数量/LED/each optic:25
 灯光颜色/Light colour:白色/White
 所需组件/Required components:

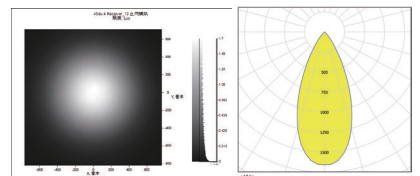

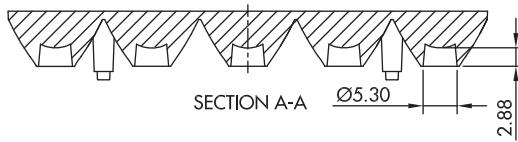
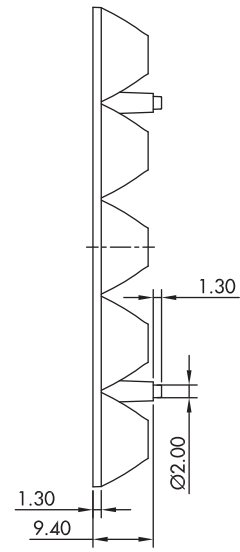
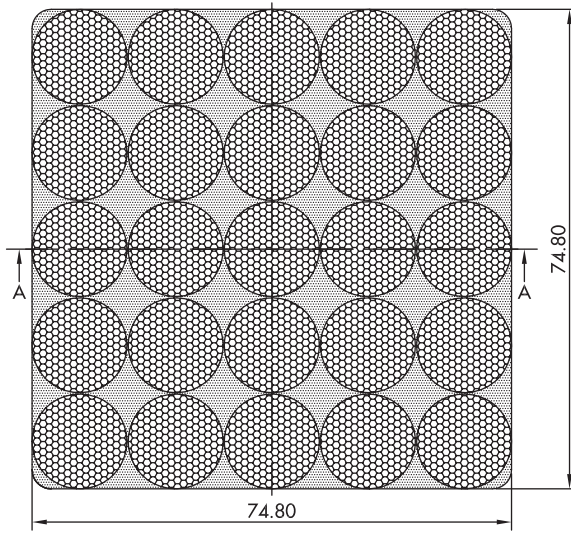

The surface treatment of the product is subject to the actual product

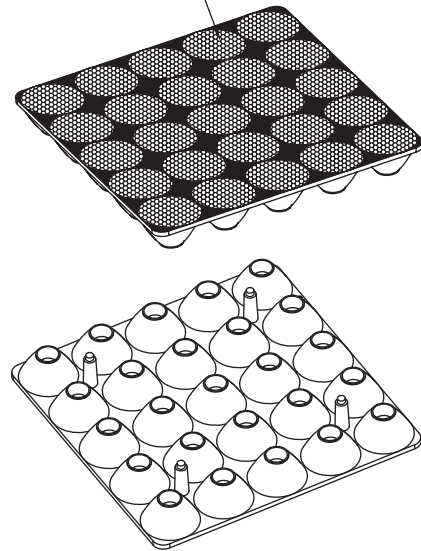
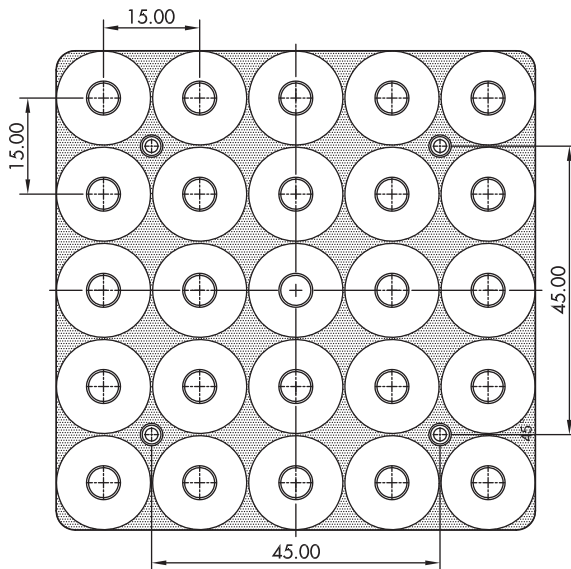

注意/NOTE:

1. 镜片表面应光滑无划痕、气泡、凹痕和黑点。

The surface of the lens should be smooth without scratches, bubbles, dents and black spots.

GENERAL TOLERANCES ISO2768-M (UNLESS STATED) 一般公差ISO 2768-M (除非另有说明)	MATERIAL 材质	PMMA	DRAWING TITLE 绘图标题	ILENS648-R7575-B45-25H1-NH	
LINEAR/线性	0~5±0.05		5~10±0.1	10~30±0.15	
ANGULAR/角度	0°~10°±1°		10°~50°±0.5°	50°~120°±0.3°	

产品包装/PRODUCTS PACKAGING

Part No.	QTY
ILENS648-R7575 -B45-25H1-NH	384pcs
Blister-380*380*20	24pcs
Cardboard box(M)	1pcs



ILENS648

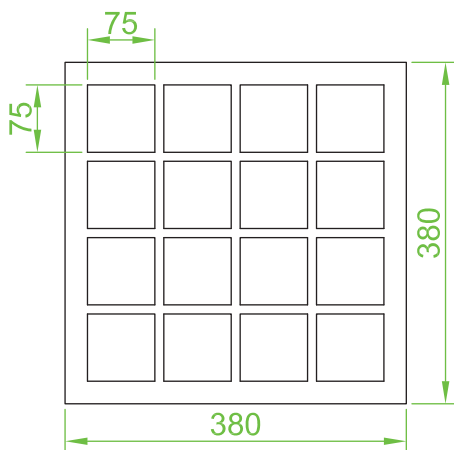

Blister-380*380*20

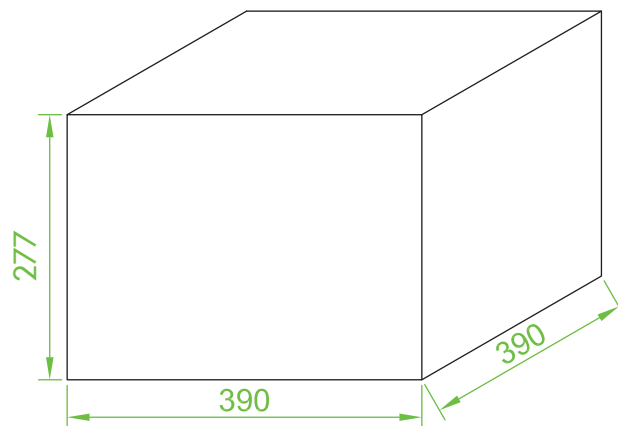

Cardboard box(M) 2:1

The schematic diagram :

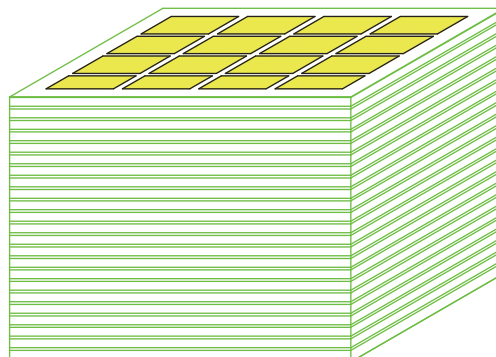
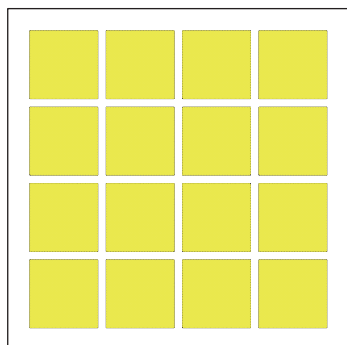

16pcs*24=384pcs